

# Plunger Pumps

*Please read and save these instructions. Read carefully before attempting to assemble, install, operate or maintain the product described. Protect yourself and others by observing all safety information. Failure to comply with instructions could result in personal injury and/or property damage! Retain instructions for future reference.*

## Description

Plunger Pumps are designed for a wide variety of high pressure washing applications. They are constructed with die-cast bodies and feature a brass head. Internal components include special thick solid ceramic plungers for long life and durability. Precision cast cooling fins are anodized for maximum heat dissipation. Oversized needle bearings on the drive side, and ball on the non-drive side together with the precision supports assure positive alignment and centering in relation to the crankcase. Valve cages of special designed Ultra-Form provide positive seating and extended life. Ball bearings on both sides of solid shaft drive pumps. One-piece connecting rods are special alloy aluminum, oversized for strength and load disbursement. These pumps are designed for, belt drive, or coupling drive systems driven by electric motor or gasoline driven systems, electric motor direct drive systems, and gasoline engine direct drive systems.



RR/RRR - N



RRA/RRV - F17



RRV - F24

### RR 1450 rpm N Version - Solid Shaft

Model	Max GPM	Max PSI
RR15.20N	4.0	2900
RR18.16N	4.8	2320

### RRV 3400 rpm D Version - 1"

Model	Max GPM	Max PSI
RRV3G36D-F24	3.0	3600
RRV3.5G36D-F24	3.5	3600
RRV4G36D-F24	4.0	3600
RRV4G40D-F24	4.0	4000

### RCA 1750 rpm N Version - Solid Shaft

Model	Max GPM	Max PSI
RRA3.5G30N	3.5	3000
RRA4G30N	4.0	3000
RRA5.5G30N	5.5	3000

### RCA 1750 rpm E Version - 1-1/8"

Model	Max GPM	Max PSI
RRA3G30E-F17	3.0	3000
RRA3.5G30E-F17	3.5	3000
RRA4G30E-F17	4.0	3000
RRA5.5G26E-F17	5.5	2600



# Plunger Pumps

Formulas	Conversions
----------	-------------

**Nozzles:**

Impact Force (lbs.) = .0526 x GPM x  $\sqrt{\text{PSI}}$

Nozzle # = GPM x  $\frac{4000}{\sqrt{\text{PSI}}}$

GPM = Nozzle # x  $\frac{\text{PSI}}{\sqrt{4000}}$

PSI = (GPM/Nozzle #)<sup>2</sup> x 4000

**Horse Power:**

$\frac{\text{GPM} \times \text{PSI}}{1714}$  = Hydraulic HP

$\frac{\text{GPM} \times \text{PSI}}{1457}$  = EBHP

$\frac{\text{EBHP} \times 1457}{\text{PSI}}$  = GPM

$\frac{\text{EBHP} \times 1457}{\text{GPM}}$  = PSI

HP loss due to altitude = 3% per 1000 FT above sea level

**Pump Speed and Flow:**

$\frac{\text{Rated GPM}}{\text{Rated RPM}} = \frac{\text{Desired GPM}}{\text{Desired RPM}}$

$\frac{\text{Motor Pulley } \varnothing}{\text{Pump RPM}} = \frac{\text{Pump Pulley } \varnothing}{\text{Motor RPM}}$

Gallons x 3.785412 = Liters

Gallons x 128 = Oz.

PSI x .06896 = Bar

Bar x 14.5038 = PSI

1 inches = 25.4 millimeters

Liters x .2642 = Gallons (US)

Ft. Lbs. x 1.356 = Newton Meters

Inch Lbs. x .11298 = Newton Meters

Newton Meters x .737562 = Ft. Lbs. (force)

Newton Meters x 8.85 = In. Lbs. (force)

Temperature = 1.8(C° + 17.78) = F°, .555(F° - 32) = C°

1 U.S. Gallon of freshwater = 8.33 lbs.

1 PSI = 2.31 feet of water

1 PSI = 2.04 inches of mercury

1 Foot of water = .433 PSI

1 Foot of water = .885 inches of mercury

1 Meter of water = 3.28 feet of water

Kilograms x 2.2 = Lbs.

## General Safety Information

### WARNINGS

#### Gasoline Drive Pumps

 The pump is designed to pump non-flammable or non-explosive fluids. These pumps are intended to pump clean filtered water only.

 Do not operate in or around an explosive environment.

 Always wear safety glasses or goggles and appropriate clothing.

 Do not alter the pump from the manufacturers design.

 Do not allow children to operate the pump.

 Never point the high-pressure discharge at a person, any part of the body or animals.

Do not operate gasoline engines in a confined area; always have adequate ventilation.

 Do not exceed the pump specifications in speed or pressure.

# Plunger Pumps

## General Safety Information (continued)

 Maximum water temperature is 140°F.





All positive displacement plunger pumps must have a safety relief valve installed on the discharge side of the pump, this valve could be either an unloader or regulator and must be of adequate flow and pressure for the pump.

Adequate protective guards must cover all moving parts. Perform routine maintenance on the pump and components.

Use only components that are rated for the flow and pressure of the pump, this would include hose, fittings, safety valves, spray guns etc.

## Electric Drive Pumps

Your power supply must conform to the system requirements.

-  The motor must be grounded. Use GFCI plugs and receivers.
-  Do not handle the pump/motor with wet hands.
-  Only use power cords that are in good condition.
-  Never pull the unit by the power cord.

Never spray or clean the unit with water

***Failure to follow these warnings may result in personal injury or damage to property.***

## Installation

### DIRECT DRIVE PUMPS

1. Install the shaft key into the keyway and apply a light coating of anti-seize on the engine shaft. (See Figure 7 & 8)
2. Align the two key ways and push the pump completely onto the engine.
3. Install all four (4) bolts and tighten evenly.
4. Remove the red shipping oil cap and install the black crankcase vent cap. (See Figure 9)
5. Install the appropriate unloader valve and other accessories.
6. Install the appropriate water inlet and discharge fittings.
7. Connect the water supply hose and high-pressure discharge hose/spray gun.
8. Turn on the water supply.
9. Open the spray gun to purge the system of any air.
10. Start the engine.
11. Adjust the engine speed and unloader valve.



Figure 7



Figure 8



Figure 9

# Plunger Pumps

## Installation (continued)

### BELT DRIVE SYSTEMS

1. Mount the pump securely to the base plate. (See Figure 10) For new installation a mounting rail kit is required, refer to parts breakdown.

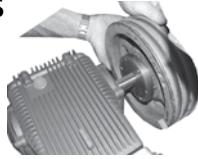

Figure 10

2. Install the pump pulley on the crankshaft. It should be as far onto the shaft as possible.



Figure 11

3. Align the pulleys so they are in line. (See Figure 11)

4. Use a belt tension gauge to assure proper tension (too much tension can cause bearing failure or damage the belts as well as cause other problems). (See Figure 12)



Figure 12

5. Installation complete.

## Maintenance

### SERVICING THE VALVES

The inlet and discharge valves in this series pumps are all the same. The valves are located under the six 21mm hex plugs. The inlet valves are located on the lower row and the discharge valves are located on the top row of the pump head.

Tools required: 21mm socket, ratchet, needle nose pliers, mechanics pick and torque wrench.

### VALVE REMOVAL

1. Remove the valve cap. (See Figure 13)
2. Inspect the valve cap O-ring for any damage, replace if necessary.
3. Use the needle nose pliers to remove the valve. (See Figure 14)
4. Use a small probe to move the poppet up and down to assure that the valve functioning properly and that no debris is stuck in the valve.
5. Inspect the valve seat o-ring for any damage, replace if necessary.



Figure 13



Figure 14

### VALVE ASSEMBLY

1. Insert the valve assembly squarely into the port push it squarely into position with a small deep well socket and extension until fully seated. (See Figure 15)
2. Install the valve cap and torque to the proper specification. (See Figure 16) (See Table D or parts breakdown)



Figure 15



Figure 16

### SERVICING THE PACKINGS/SEALS

To access the water seals for inspection or replacement, you will first need to remove the head of the pump.

Tools required: 5mm hex socket, ratchet, (2) long screwdrivers, reversible pliers, mechanics pick and torque wrench.

# Plunger Pumps

## Service Pumps (continued)

### DISASSEMBLY

1. First remove the eight 5mm head bolts.
2. Place the screwdrivers as shown between the head and crankcase of the pump, lifting one up and the other down. The head should start to lift off of the plungers. (See Figure 17)



Figure 17

3. When you remove the head you may notice that some of the water seals have stayed on the plungers and some in the head. To remove the seals from the plungers simple turn the assemblies and pull off. (See Figure 18)



Figure 18

4. If the seal assemblies are in the head use the reversible pliers to grab the seal retainer on the outside ring, twist the retainer in either direction (this is done to free the retainer O-ring which is stuck to the manifold) and lift out. (See Figure 19)



Figure 19

5. With your finger pull out the brass intermediate guide ring.
6. With your finger pull the high-pressure seal and head ring out of the head. (See Figure 20)



Figure 20

7. The low-pressure seal is located in the brass seal retainer. Using the mechanics pick, go in between the seal and retainer and pull the seal straight out. (See Figure 21)



Figure 21

8. Remove the seal retainer O-ring with the mechanics pick. (See Figure 22)



Figure 22

### ASSEMBLY

1. Install the plastic head ring into the head (the flat side is on the bottom).

2. Install the high-pressure seal. Place the seal so the open "V" portion is toward the head ring. You need to place the seal at an angle and pull and push to work the seal into position with your fingers (do not use any tools you may damage the seal). Make sure the seal is totally seated against the head ring. (See Figure 23)



Figure 23

3. Place the brass intermediate ring squarely over the high-pressure seal

4. Install the low-pressure seals into the rear piston guide. Make sure the brown scrapper ring is in place on the backside of the seal (NOTE: Care must be taken so the ring does not fall out during assembly). The scrapper side of the seal goes into the piston guide. Push the seal down until fully seated. You should be looking at the open side of the seal. (See Figure 24)



Figure 24

# Plunger Pumps

## Service Pumps (continued)

5. Install the retainer O-ring.
6. Squarely seat the retainer into the head and push with even pressure until it snaps into position. (See Figure 25)



Figure 25

3. Twist and pull the plunger off the plunger rod. (See Figure 28)
4. Remove the plunger rod O-ring seal with the mechanics pick.
5. Remove the brass slinger. At this point clean any thread locker that is left on the plunger rod and retaining nut threads.



Figure 28

## SERVICING THE PLUNGERS

If the plungers are not damaged they do not need any servicing.

Tools required: 13mm socket, ratchet, mechanics pick, taper blade gasket scraper, thread sealant and torque wrench.

**NOTE:** Be very careful when working with the plungers, they are made from ceramic which is brittle and can be damaged.

Any time you remove a plunger it is recommended you replace the slinger washer, O-ring and top plunger washer. The washers are a cushion for the ceramic plunger and compress when first used and the O-ring will take a set to create a seal and usually will not spring back to its original shape. By not replacing these parts you run the risk of breaking a plunger or having a water leak.

## DISASSEMBLY

1. Remove the plunger retainer nut. (See Figure 26)
2. Insert the gasket scraper between the copper washer and plunger to remove the washer. (See Figure 27)



Figure 26



Figure 27

## ASSEMBLY

1. Install the brass slinger washer.
2. Install the plunger rod O-ring. Place a light film of oil on the O-ring.
3. Install the plunger by pushing straight down and twisting slightly in either direction. Make sure you fully seat the plunger. (See Figure 29)
4. Install the small copper washer on top of the plunger and place a small quantity of thread sealant in the thread. Install the plunger nut and tighten to the required torque. (See Figure 30) (See Table D or parts breakdown)



Figure 29



Figure 30

## PUMP HEAD TO DRIVE END INSTALLATION

1. Turn the crankshaft to align the plungers as shown. (See Figure 31)



Figure 31

# Plunger Pumps

## Service Pumps (continued)

- Place the head evenly onto the plungers and push it until it makes contact with the drive end of the pump. (See Figure 32)



**Figure 32**

- Torque the head bolt as shown in the tightening sequence diagram. (See Figure 33 & 34) (See Table D or parts breakdown)



**Figure 33**



**Figure 34**

## OIL CHANGE

Change oil after first 50 hours of use. Then every 500 hours. Refer to parts breakdown for oil type.

## WINTER OR LONG TIME STORAGE

- Drain all of the water out of the pump.
- Run a 50% solution of a RV or non-toxic/biodegradable antifreeze through the pump.
- Flush the pump with fresh water before the next use.
- In freezing conditions failure to do this may cause internal pump damage.
- For long periods of storage in non-freezing areas the solution will keep the seals and O-rings lubricated.



**Troubleshooting**

<b>Symptom</b>	<b>Possible Cause(s)</b>	<b>Corrective Action</b>
Oil leak between crankcase and pumping section	Worn rod oil seals	Replace crankcase piston rod seals
Frequent or premature failure of the packing	1 Cracked, damaged or worn plunger	1 Replace plungers
	2 Overpressure to inlet manifold	2 Reduce inlet pressure
	3 Material in the fluid being pumped	3 Install proper filtration on pump inlet plumbing
	4 Excessive pressure and/or temperature of fluid being pumped	4 Check pressures and fluid inlet temperature; be sure they are within specified range
	5 Running pump dry	5 Do not run pump without water
Pump runs but produces no flow	Pump is not primed	Flood suction then restart pump
Pump fails to prime	Air is trapped inside pump	Disconnect discharge hose from pump. Flood suction hose, restart pump and run pump until all air has been evacuated
Pump loses prime, chattering noise, pressure fluctuates	1 Air leak in suction hose or inlet	1 Remove suction line and inspect it for a loose liner or debris lodged in hose. Avoid all unnecessary bends. Do not kink hose
	2 Clogged suction strainer	2 Clean strainer
Low pressure at nozzle	1 Unloader valve is by-passing	1 Make sure unloader is adjusted properly and by-pass seat is not leaking
	2 Incorrect or worn nozzle	2 Make sure nozzle is matched to the flow and pressure of the pump. If the nozzle is worn, replace
	3 Worn packing or valves	3 Replace packing or valves
Pressure gauge fluctuates	1 Valves worn or blocked by foreign bodies	1 Clean or replace valves
	2 Packing worn	2 Replace packing
Low pressure	1 Worn nozzle	1 Replace with nozzle of proper size
	2 Belt slippage	2 Tighten or replace with correct belt

**Troubleshooting (cont.)**

<b>Symptom</b>	<b>Possible Cause(s)</b>	<b>Corrective Action</b>
Low pressure (cont.)	3 Air leak in inlet plumbing	3 Disassemble, reseal and reassemble
	4 Relief valve stuck, partially plugged or improperly adjusted valve seat worn	4 Clean and adjust relief valve; check for worn or dirty valve seats
	5 Worn packing. Abrasive in pumped in cavitation. Inadequate water	5 Install proper filter suction at inlet manifold must be limited to lifting less than 20 feet of water or 8.5 psi vacuum
	6 Worn inlet, discharge valve blocked or dirty	6 Replace inlet and discharge valve
Pump runs extremely rough, pressure very low	1 Inlet restrictions and/or air leaks.	1 Clean out foreign material
	2 Stuck inlet or discharge valve	2 Replace worn valves
Water leakage from under manifold	Worn packing or cracked plunger	Install new packing or plunger
Slight leak, oil leaking in the area of crankshaft	1 Worn crankshaft seal or improperly installed oil seal o-ring	1 Remove oil seal retainer and replace damaged O-ring and/or seals
	2 Bad bearing	2 Replace bearing
Excessive play in the end of the crankshaft pulley	Worn main bearing from excessive tension on drive belt	Replace crankcase bearing and/or tension drive belt
Water in crankcase	1 Humid air condensing into water inside the crankcase	1 Change oil intervals
	2 Worn packing and/or cracked plunger	2 Replace packing. Replace plunger
Loud knocking noise in pump	1 Cavitation or sucking air	1 Check water supply is turned on
	2 Pulley loose on crankshaft	2 Check key and tighten set screw
	3 Broken or worn bearing	3 Replace bearing

# RR 1450 RPM RRA 1750 RPM

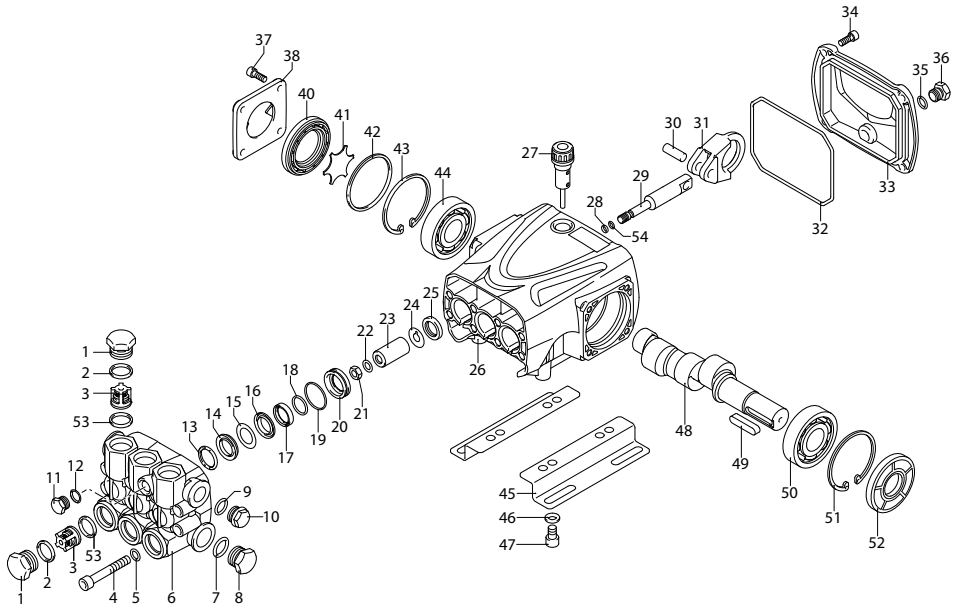

## Repair Kits

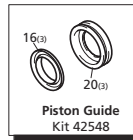
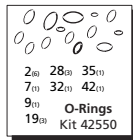
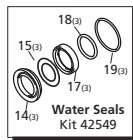
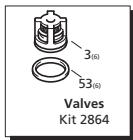

Pos.	Code	Description	Qty.	Pos.	Code	Description	Qty.
1	960090	Plug	6	40	3220080	Oil indicator	1
2	960160	O-ring	6	41	3320090	Disc	1
3	1389051	Complete valve	6	42	650560	O-ring	1
4	800860	Screw	8	43	200390	Snap ring	1
5	1381850	Washer	8	44	1981210	Bearing	1
6	3220020	Head	1	45	3200210	Base	2
7	180101	O-ring	1	46	1322640	Washer	4
8	820361	Plug	1	47	850250	Screw	4
9	740290	O-ring	1	48	3220050	Crankshaft - Solid Shaft	○1
10	1980740	Plug	1	48	3220330	Crankshaft - Solid Shaft	●1
11	880581	Plug	1	48	3220360	Crankshaft - Solid Shaft	■1
12	820510	O-ring	1	49	3200230	Key	1
13	1780140	Ring	3	50	1981210	Bearing	1
14	1780720	Gasket	3	51	200390	Circlip	1
15	3200250	Ring	3	52	3220280	Snap ring	1
16	3220130	Piston guide	3	53	880830	O-ring	6
17	3200142	Gasket	3	54	1080550	Ring	3
18	3200260	Ring	3				
19	770260	O-ring	3				
20	3220120	Piston guide	3	AR64516	Oil		2
21	1260110	Nut	3		<i>OIL CAPACITY - OZ</i>		
22	1260100	Washer	3				
23	1780080	Piston	3				
24	1260091	Spacer	3				
25	1260460	Ring	3				
26	3220010	Pump body	1				
27	880130	Plug	1				
28	480480	O-ring	3				
29	3220060	Piston	3				
30	3220070	Conrod pin	3				
31	3220040	Conrod	3				
32	651540	O-ring	1				
33	3220030	Rear cover	1				
34	3200220	Screw	4				
35	820510	O-ring	1				
36	880581	Plug	1				
37	1200430	Screw	4				
38	3200070	Cover	1				

**Legend**

For ○	For ●	For ■
RR18.16N	RRA3.5G30N	RR15.20N
RRA5.5G30N		RRA4G30N

# Plunger Pumps

## RRA 1750 RPM

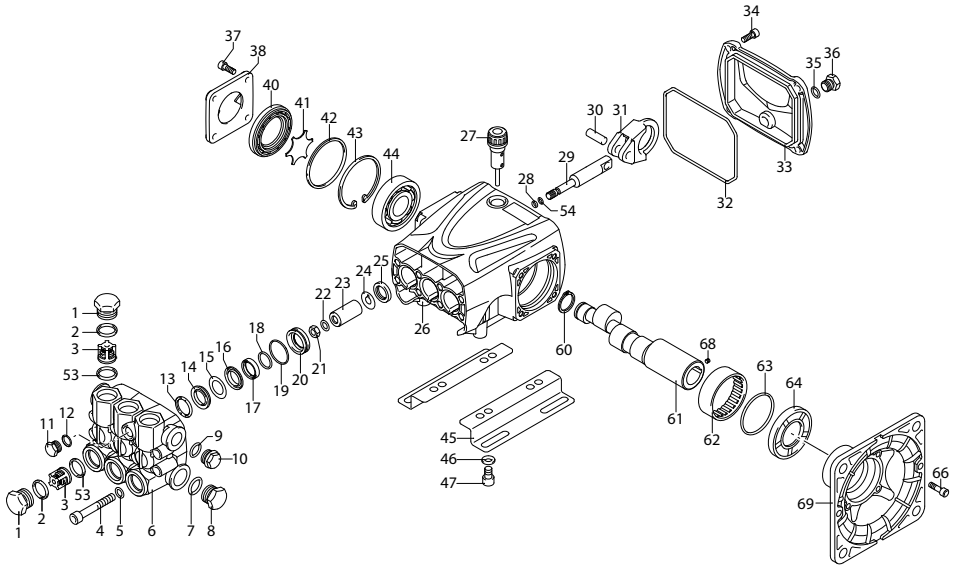

### Repair Kits

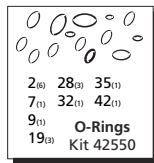
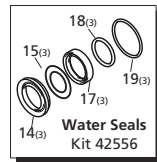
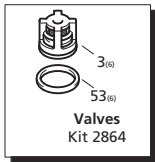

Pos.	Code	Description	Qty.	Pos.	Code	Description	Qty.
1	960090	Plug	6	40	3220080	Oil indicator	1
2	960160	O-ring	6	41	3320090	Disc	1
3	1389051	Complete valve	6	42	650560	O-ring	1
4	800860	Screw	8	43	200390	Snap ring	1
5	1381850	Washer	8	44	1981210	Bearing	1
6	3220020	Head	1	45	3200210	Base	2
7	180101	O-ring	1	46	1322640	Washer	4
8	820361	Plug	1	47	850250	Screw	4
9	740290	O-ring	1	48	3220050	Crankshaft - Solid Shaft	○1
10	1980740	Plug	1	48	3220330	Crankshaft - Solid Shaft	●1
11	880581	Plug	1	48	3220360	Crankshaft - Solid Shaft	■1
12	820510	O-ring	1	49	3200230	Key	1
13	1780140	Ring	3	50	1981210	Bearing	1
14	1780720	Gasket	3	51	200390	Circlip	1
15	3200250	Ring	3	52	3220280	Snap ring	1
16	3220130	Piston guide	3	53	880830	O-ring	6
17	3200142	Gasket	3	54	1080550	Ring	3
18	3200260	Ring	3				
19	770260	O-ring	3				
20	3220120	Piston guide	3	AR64516	Oil		2
21	1260110	Nut	3		<i>OIL CAPACITY - OZ</i>		
22	1260100	Washer	3				
23	1780080	Piston	3				
24	1260091	Spacer	3				
25	1260460	Ring	3				
26	3220010	Pump body	1				
27	880130	Plug	1				
28	480480	O-ring	3				
29	3220060	Piston	3				
30	3220070	Conrod pin	3				
31	3220040	Conrod	3				
32	651540	O-ring	1				
33	3220030	Rear cover	1				
34	3200220	Screw	4				
35	820510	O-ring	1				
36	880581	Plug	1				
37	1200430	Screw	4				
38	3200070	Cover	1				

**Legend**

For ○  
RR18.16N  
RRA5.5G30N

For ●  
RRA3.5G30N

For ■  
RR15.20N  
RRA4G30N



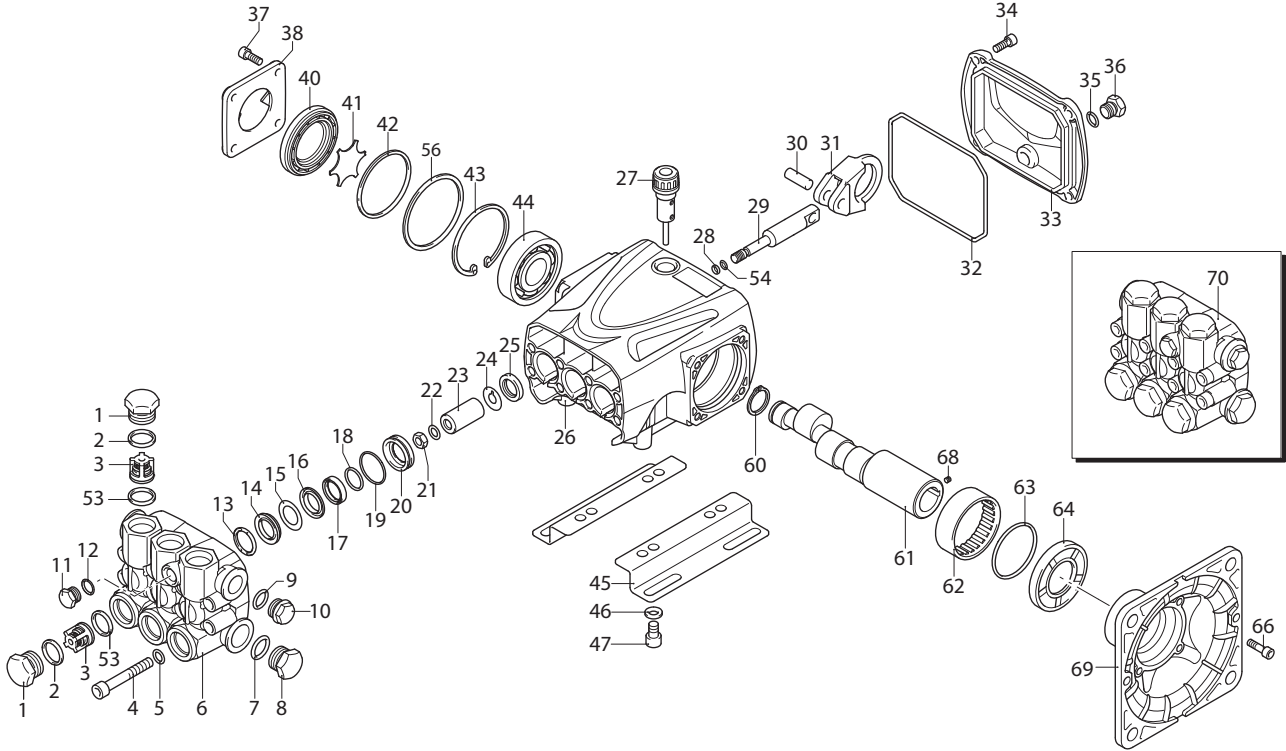

**Repair Kits**

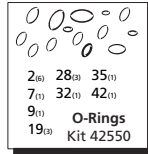
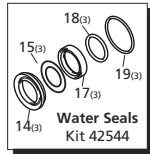
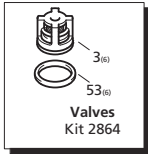

Pos	Code	Description	Qty	Pos	Code	Description	Qty	Legend		
	960090	Valve Cap	(478 in/lbs) 6	34	3200220	Screw TCEI M 6x16	(71 in/lbs) 4	For ●	For ◆	For ■
	960850	Valve Cap SST	(478 in/lbs) 6	35	820510	O-Ring ø 10.82x1.78	1	For RRA3G30E	For RRA4G30E	For RRA5.5G26E
	9600909	Valve Cap - threaded 1/4" brass	(478 in/lbs) 6	36	880581	Plug 1/4" G	(133 in/lbs) 1			
	9608507	Valve Cap - threaded 1/4" SST	(478 in/lbs) 6	37	1200430	Screw M 6x16	(92 in/lbs) 4			
2	960160	O-Ring ø 17.86x2.62	6	38	3200070	Cover	1			
3	1389051	Complete valve	6	40	3220080	Oil indicator	1			
4	800860	Screw M 8x55	(225 in/lbs) 8	41	3200090	Disc	1			
5	1381850	Washer	8	42	650560	O-Ring ø 56.82x2.62	1			
6	3220020	Head	1	43	200390	Snap ring øi 62	1			
7	180101	O-Ring ø 17.5x2	1	44	1981210	Bearing	1			
8	820361	Plug 1/2" G	(345 in/lbs) 1	45	3200210	Base	2			
9	740290	O-Ring ø 14x1.78	1	46	1322640	Washer	4			
10	1980740	Plug 3/8" G	(221 in/lbs) 1	47	850250	Screw M 8x12	4			
11	880581	Plug 1/4" G	(133 in/lbs) 1	53	80830	O-Ring ø 15.54x2.62	6			
12	820510	O-Ring ø 10.82x1.78	1	54	1080550	Ring	3			
13	1780140	Ring	3	56	3220780	O-Ring ø 61.8x0.5	1			
14	1780720	High pressure seal	3	60	1260770	Circlip	1			
15	3200250	Ring	3	61	3220160	Crankshaft - Hollow Shaft 1-1/8 ●	1			
16	3220130	Piston guide - front	3	61	3220180	Crankshaft - Hollow Shaft 1-1/8 ◆	1			
17	3200142	Low pressure seal	3	61	3220400	Crankshaft - Hollow Shaft 1-1/8 ■	1			
18	3200260	Ring	3	62	3220260	Bearing	1			
19	770260	O-Ring ø 23.52x1.78	3	63	3220430	O-Ring ø 56.87x1.78	1			
20	3220120	Piston guide - rear	3	64	3220270	Snap ring	1			
21	1260110	Nut M 8	(106 in/lbs) 3	66	780060	Screw M 6x25	(92 in/lbs) 4			
22	1260100	Washer	3	68	820440	Grub screw	◆■ 1			
23	1780080	Piston	3	69	3220190	Flange	1			
24	1260091	Spacer	3	70	3229200	Complete head assembly	1			
25	1260460	Ring	3							
26	3220010	Pump body	1		AR64516	Oil	2			
27	880130	Plug	(44 in/lbs) 1			<i>OIL CAPACITY - 13.35 OZ</i>				
28	480480	O-Ring ø 4.48x1.78	3							
29	3220060	Piston	3							
30	3220070	Conrod pin	3							
31	3220040	Conrod	3							
32	651540	O-Ring ø 107.62x2.62	1							
33	3220030	Rear cover	1							

# Plunger Pumps

## RRV 3400 RPM

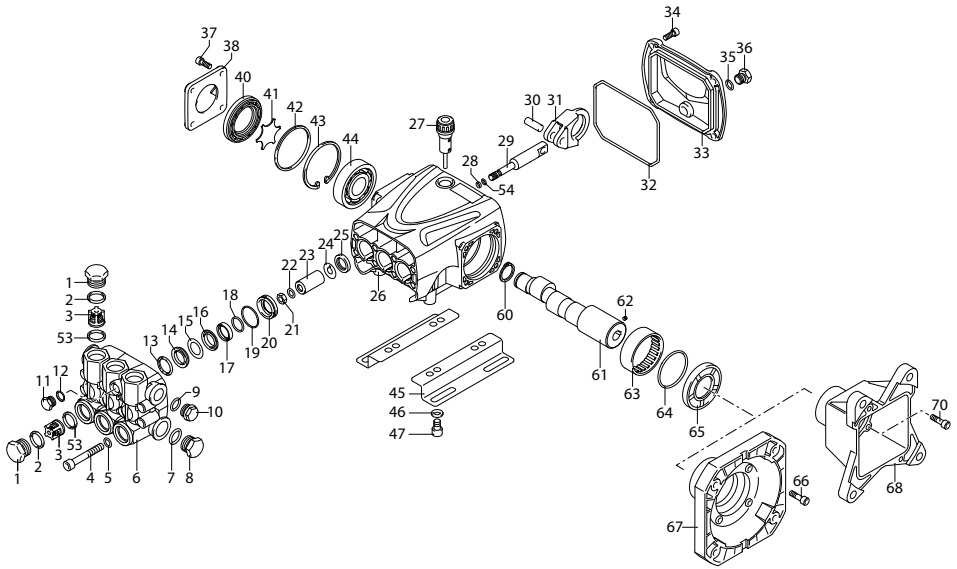

### Repair Kits

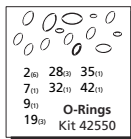
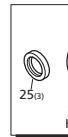
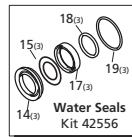
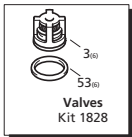

Pos.	Code	Description	Qty.	Pos.	Code	Description	Qty.
1	960090	Plug	6	40	3220080	Oil indicator	1
2	960160	O-ring	6	41	3320090	Disc	1
3	889052	Complete valve	6	42	650560	O-ring	1
4	800860	Screw	8	43	200390	Snap ring	1
5	1381850	Washer	8	44	1981210	Bearing	1
6	3220090	Head	1	45	3200210	Base	2
7	180101	O-ring	1	46	1322640	Washer	4
8	820361	Plug	1	47	850250	Screw	4
9	740290	O-ring	1	53	880830	O-ring	6
10	1980740	Plug	1	54	1080550	Ring	3
11	880581	Plug	1	60	1260770	Circlip	1
12	820510	O-ring	1	61	3220240	Crankshaft - Hollow Shaft ◆	1
13	2760220	Ring	3	61	3220450	Crankshaft - Hollow Shaft ●	1
14	1342761	Gasket	3	61	3220460	Crankshaft - Hollow Shaft ○	1
15	3200680	Ring	3	62	820440	Grub screw	1
16	3220150	Piston guide	3	63	3220260	Bearing	1
17	3200690	Gasket	3	64	3220430	O-ring	1
18	3200700	Ring	3	65	3220270	Snap ring	1
19	770260	O-ring	3	66	780060	Screw	4
20	3220140	Piston guide	3	68		Flange	1
21	1260110	Nut	3	70		Screw	4
22	1260100	Washer	3				
23	1780070	Piston	3		AR64516	Oil	2
24	1260091	Spacer	3			<i>OIL CAPACITY - 13.35 oz</i>	
25	1260460	Ring	3				
26	3220010	Pump body	1				
27	880130	Plug	1				
28	480480	O-ring	3				
29	3220060	Piston	3				
30	3220070	Conrod pin	3				
31	3220040	Conrod	3				
32	651540	O-ring	1				
33	3220030	Rear cover	1				
34	3200220	Screw	4				
35	820510	O-ring	1				
36	880581	Plug	1				
37	1200430	Screw	4				
38	3200070	Cover	1				

**Legend**

For ○  
RRV3G36D

For ●  
RRV3.5G36D

For ◆  
RRV4G36D  
RRV4G40D







# Plunger Pumps

## Torque Specifications in/lbs:(ft/lbs)

Oil Capacity	Manifold (Head)	Piston Nut	Rear Cover	Side Cover	Valve Cap	Connecting Rods
12	92/(5)	N/A	71/(6)	N/A	442/(37)	N/A

## LIMITED WARRANTY

Annovi Reverberi (A.R.) *Cam Shaft Plunger Pumps* are warranted for a period of five years and *Axial Radial Pumps* are warranted for a period of one year to the original purchaser. *Electric Pressure Washers* are warranted for a period of one year to the original purchaser. This is from the date shipped from factory or U.S. Warehouse. **AR, ArrowLine** and **GF** accessories are warranted for a period of 90 days.

Warranty covers manufacturing defects or workmanship that may develop under normal use and service in a manner up to the directions and usage recommended by the manufacturer.

Warranty does not apply to misuse or when pump or accessory is altered or used in excess of recommended speeds, pressures, temperatures or handling fluids not suitable for pump or accessory material construction. Warranty does not apply to normal wear, freight damage, freezing damage or damage caused by parts or accessories not supplied by AR North America, Inc.

Liability of manufacturer for warranty is limited to repair or replacement at the option of the manufacturer when such products are found to be of original defect or workmanship at the time it was shipped from factory. This warranty is in lieu of all other warranties, expressed or implied, including any warranty of merchantability and of any and all other obligations or liabilities on the part of the manufacturers or equipment.

## WARRANTY RETURNS

Items returned for warranty consideration must have a **Returned Merchandise Authorization (RMA)** number. All unauthorized returns will be refused and shipped back to sender. Please fax requests to: 763-398-2009 or e-mail to [shop@arnorthamerica.com](mailto:shop@arnorthamerica.com).